



Power Anytime, Anywhere

Tesla™ TI200-PFC Ground Power Unit User Manual



Built Smart...Proven Tough

Tesla Industries, Inc.
101 Centerpoint Blvd.
New Castle, DE 19720
(302) 324-8910 Phone
(302) 324-8912 Fax
www.teslaind.com
www.tesla1.com

NOTE: All users must read this entire manual prior to operating the TI2000-PFC.

The TI2000-PFC is a limited maintenance-free and sealed unit. No repairs are authorized. Warranty will be voided if unit is tampered with in any way, or if unauthorized repairs are made. For technical support please contact:

TESLA™ INDUSTRIES INCORPORATED
101 CENTERPOINT BLVD.
CENTERPOINT INDUSTRIAL PARK, NEW CASTLE, DELAWARE 19720
PHONE: (302) 324-8910 FAX: (302) 324-8912
WEBSITE: www.teslaind.com ♦ www.tesla1.com EMAIL: tesla1@teslaind.com



CAUTION

Shock Hazard Potential

Improper use or failure to follow instructions in this user manual can result in unit damage and/or injury or death by electrical shock. Always protect the unit from short circuit.

Any attempts to open or examine the inside of the unit via a tool or device (borescope, probe, etc.) can result in unit failure and/or injury by electrical shock. This GPU is maintenance free and should not be opened or disassembled for any reason.

Shipping Hazards: None.



NOTE

Unit is not rated for engine starting. It is to be used for ground maintenance only.

All Ground Power Units, Micro Power Units (Aviation Batteries) and including, but not limited to, Battery Chargers/Conditioners, manufactured by Tesla™ Industries, Inc., are able to safely and effectively charge any AGM, Lead Acid battery.

The Tesla™ GPU's and chargers are voltage and current regulated to 0.01% (dual loop). The charging voltage is calibrated, by Tesla™, to 28.6 volts and is pure dc (no power line ripple).

Maximum Charge Voltage by Battery Type

Type:	Charging Voltage / Cell	Charging Voltage / 12v	Charging Voltage / 24v
SLI/Flooded	2.366v to 2.416v	14.2v to 14.5v	28.4v to 29v
Lead Acid/Flooded	2.366v to 2.416v	14.2v to 14.5v	28.4v to 29v
Sealed Lead Acid	2.366v to 2.416v	14.2v to 14.5v	28.4v to 29v
VRLA	2.366v to 2.416v	14.2v to 14.5v	28.4v to 29v
AGM	2.433v to 2.466v	14.6v to 14.8v	29.2v to 29.6v
GEL	2.350v to 2.400v	14.1v to 14.4v	28.2v to 28.8v

Copyright © 2019 by Tesla™ Industries, Incorporated. All rights reserved.

Table of Contents

Section 1 – Safety Review	1
1.1 – Safety Notices	1
1.2 – Symbols	2
1.3 – Hazards	2
1.4 – Important Safety Precautions	2
1.5 – Extreme Environments	2
Section 2 – Product Overview	3
2.1 – Introduction	3
2.2 – Indication of Terms: Shall, Should, May	3
2.3 – Front Panel Overview	4
2.4 – General Specifications	5
2.5 – Physical Dimensions	6
2.6 – Airflow Ports	6
2.7 – Operating Positions	7
2.8 – Active Power Factor Correction	8-9
2.9 – AC Input Circuit Breaker	9
2.10 – AC Line Cord	10
2.11 – 24 Vdc Output Connector	10
2.12 – Interface Connector	11
2.13 – Output Power Status LED Indicator	11
Section 3 – Operating Procedures	12
3.1 – Operating Procedures	12
3.2 – General	12
3.3 – Operating Limits and Restrictions	12
3.4 – Environmental	12
3.5 – Pre-Operation	13
3.6 – Regulated AC Power	13
3.7 – Regulated 28.5 Vdc Output Ground Power	14
3.8 – Turning On AC Input Circuit Breaker	15
3.9 – Removing DC Power Supply from Vehicle or Aircraft	15

Section 4 – Post-Operation	16
4.1 – General	16
4.2 – After Use	16
Section 5 – Unit Care and Maintenance	17
5.1 – Unit Care	17
5.2 – Normal Functional Test Procedures	18-19
5.3 – Unit Servicing	19
5.4 – Transporting Unit	20
5.5 – Packaging and Shipping	20
Section 6 – Troubleshooting and FAQ	21
6.1 - Frequently Asked Questions	21-22
6.2 - Basic Unit Troubleshooting	23
Section 7 – Optional Accessories	24
7.1 - Transport Dolly	24
7.2 – Cobra™ DC Replacement Contacts and Tools	24
Repair Request Form	25

Abbreviations and Symbols

Abbreviations that may be used within the text, headings and titles of this manual.

LIST OF ABBREVIATIONS



Abbreviation **Definition**

ac	Alternating Current
AFT	Airflow Technology
AWG	American Wire Gauge
amp or A	Ampere
cont	Continuous
°C	Degree Celsius
°F	Degree Fahrenheit
dc	Direct Current
EFF	Efficiency
ft	Feet
FWD	Forward
GPU	Ground Power Unit
Hr	Hour
Hz	Hertz
kg	Kilograms
kHz	Kilohertz
kW	Kilowatts
LED	Light Emitting Diode
max	Maximum
MΩ	megaohm
min	Minimum
MPU	Micro Power Unit
NEMA	National Electrical Manufacturers Association
Ω	ohm
PF	power factor
PFC	power factor correction
rms	root-mean-square
THD	Total Harmonic Distortion
TMDE	Test, Measurement, & Diagnostic Equipment
UAV	Unmanned aerial vehicle
Vac	Volts, Alternating Current
Vdc	Volts, Direct Current
W	watts

Section 1 – Safety Review

1.1 - Safety Notices

Safety notices appear throughout this manual to alert the user to important information regarding proper installation, operation, maintenance and storage of the unit. These notices, as illustrated below, contain a key word that indicates the level of hazard and a triangular icon that indicates the specific type of hazard.

 WARNING	Indicates a condition, operating procedure or practice, which if not adhered to could result in serious injury or death.
 CAUTION	Indicates a condition or operating procedure, which if not strictly adhered to could result in damage or destruction of equipment.
 NOTE	Indicates a condition, operating procedure or practice, which is essential to highlight.

1.2 - Symbols

The following symbols will appear within the warning triangles to alert the user to the specific type of danger or hazard.



Figure 1.2.1 – Different types of hazard and caution symbols

1.3 – Hazards



WARNING

Shock Hazard Potential

Severe injury or death from electrical shock will occur if either the user or the TI200-PFC is wet while operating the unit with the 200-260 Vac power source attached. Be sure to disconnect ac power from the ac source if the TI200-PFC has come into contact with water. If the AC Input Circuit Breaker has tripped due to water infiltration, DO NOT try to reset circuit breaker until GPU has dried completely.



WARNING

Shock Hazard Potential

Severe injury or death from electrical shock can occur when damp electrical plugs are connected to the TI200-PFC. Make sure the electrical outlet is switched off before making any connections. Failure to use proper grounding can cause potential shock hazard!



CAUTION

Unit Damage Potential

The unit will be damaged if unapproved ac power is applied. This Unit operates from Single Phase 200-260 Vac, 40 Hz-450 Hz. This must match ac power source (hangar wall, flight line ac power) prior to connecting the TI200-PFC.

1.4 – Important Safety Precautions



WARNING

Fire/Explosion Hazard Potential

Severe injury or death from fire or explosion can occur if electrical sparks are produced near fuel vapors. Power output is 28.5 Vdc. DO NOT CONNECT ac power to GPU while operating or handling any aircraft fuel.

1.5 – Extreme Environments



CAUTION

Unit Damage Potential

The TI200-PFC is equipped with a charger temperature switch that automatically disables ac and charging functions when the internal temperature reaches above 150°F (65°C). This protects the unit from overheating and damage. If the unit shuts down, move the unit into a cooler climate such as shade or air conditioning when possible. Perform a full function test prior to use after the unit has been allowed to cool.

Section 2 – Product Overview

2.1 – Introduction

Thank you and congratulations on the purchase of your new TI200-PFC Ground Power Unit.

This GPU is one of Tesla™ Industries latest advancements in power technology development. This GPU features a 6.5kW active Power Factor Correction (PFC) that is capable of pulling a current waveform identical to the applied voltage waveform. This is the only PFC on the market that is capable of operating at 40 Hz to 450 Hz with 2% THD (Total Harmonic Distortion).

What this means for the end user is that this GPU is capable of producing the same output power of one of our three phase GPU's while operating off of single phase power. It offers a wide versatility of power options while effectively lowering energy consumption.

The TI200-PFC provides 200 amps @ 28.5 Volts of pure regulated flat line dc power for vehicle ground support, avionics, battery charging, power for training facility operations, and for all 24 Volt systems.

This manual contains the complete operating instructions and procedures for the TI200-PFC needed to safely and efficiently operate this GPU.



Figure 2.1.1 – TI200-PFC



NOTE

Unit is not rated for engine starting. It is to be used for ground maintenance only.

2.2 – Indication of Terms: Shall, Should and May

Within this technical manual the word “shall” is used to indicate a mandatory requirement for proper operation and warranty purposes. The word “should” is used to indicate a non-mandatory but preferred method of accomplishment. The word “may” is used to indicate an acceptable method of accomplishment.

2.3 – Front Panel Overview



1. **Output Power Status Indicator** – Displays the amount of available power the GPU can supply.
2. **24 Vdc Output Connector** – Provides 200 amps of continuous power at 28.5 Vdc (when plugged into ac power).
3. **Output Connector Protective Cover** - Protects Output Connector from dust and foreign materials.
4. **Interface Connector** - Used for factory calibrations.
5. **Carrying Handle** – Allows for easy transport of unit.
6. **External AC Circuit Breaker** – Protects the internal electrical circuit from damage caused by overload or short circuit.
7. **50 Amp Twist-Lock AC Power Cord** – Provides 33.5 amps @ 208 Vac 60Hz (50 amp service required).
8. **Air Intake Ports** – Provide airflow for cooling internal electronics.

2.4 – General Specifications

Electrical

AC Input:

- Operates from Single Phase 200-260 Vac, 40 Hz-450 Hz
- 33.5 amps @ 208 Vac - 6968 Watts
- 50 amp Service Required
- Contact Tesla™ Industries for Plug Configuration

PFC:

- .999% power factor
- <2% THD (Total Harmonic Distortion)

DC Output Power:

- 200 amps continuous @ 28.5 Vdc (when plugged into ac power)

Size:

- 27.61" long x 10.4" wide x 10.56" high
- 701.3 mm x 264.2 mm x 268.25 mm

Weight

- 58 lbs (26.4 kg)

Operating Temperature:

- -40°C to +55°C (-40°F to 131°F)

Storage Temperature:

- -65°C to +105°C (-85°F to 221°F)

2.5 – Physical Dimensions

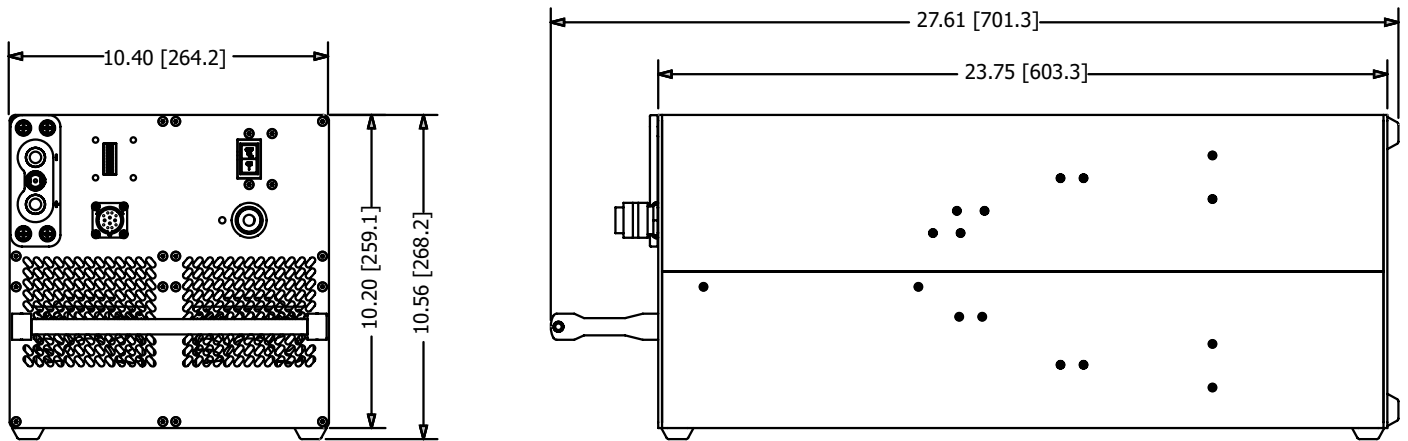



Figure 2.5.1 – TI200-PFC physical dimensions

2.6 – Airflow Ports

 CAUTION	Damage may occur if the TI200-PFC's air intake or outlet ports are obstructed. Ensure that ports are clear at all times.
--	--

When the TI200-PFC is plugged into ac power, the internal cooling system will efficiently regulate unit temperature regardless of load. At room temperature (+77 °F) the exhaust air will not exceed the ambient temperature by more than 5 °F. In more extreme temperatures (greater than 90 °F) the exhaust air will not exceed the ambient temperature by more than 10 °F.

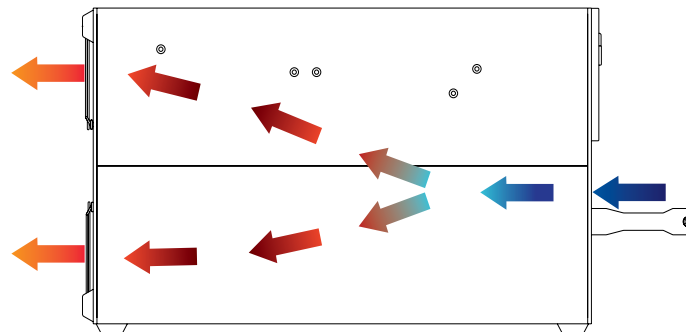

Figure 2.6.1 – Air intake, exhaust ports and internal air circulation

2.7– Operating Positions

The TI200-PFC can be operated in both the horizontal (Figure 2.7.1) and vertical (Figure 2.7.2) positions as shown. Make sure that the airflow is not obstructed from air intake (figure 2.7.3) and outlet (Figure 2.7.4).

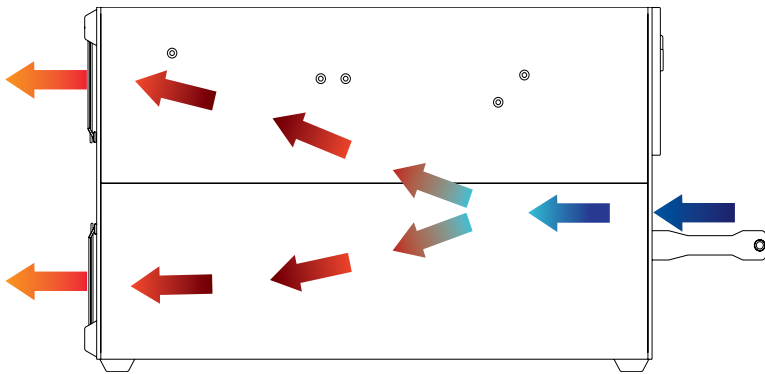

Figure 2.7.1: Horizontal Position

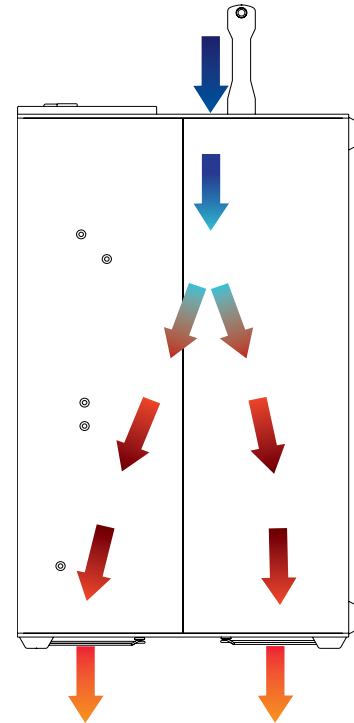

Figure 2.7.2: Vertical Position

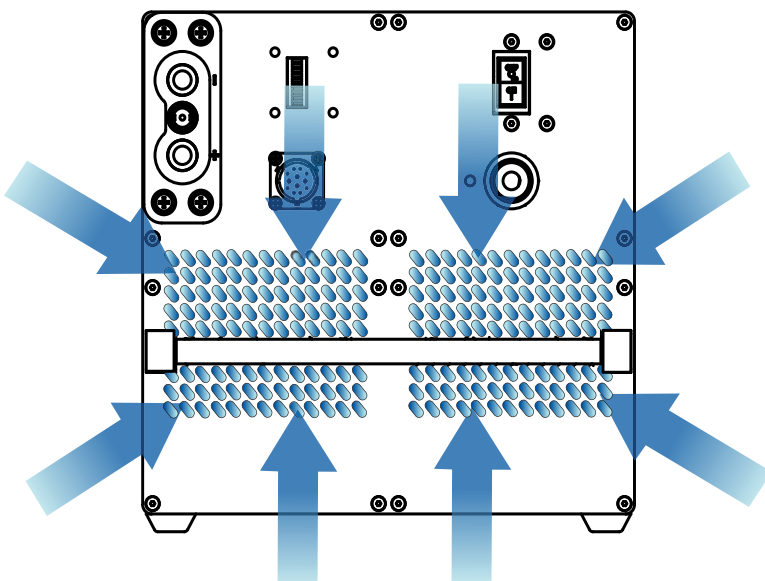

Figure 2.7.3: Front Inlet

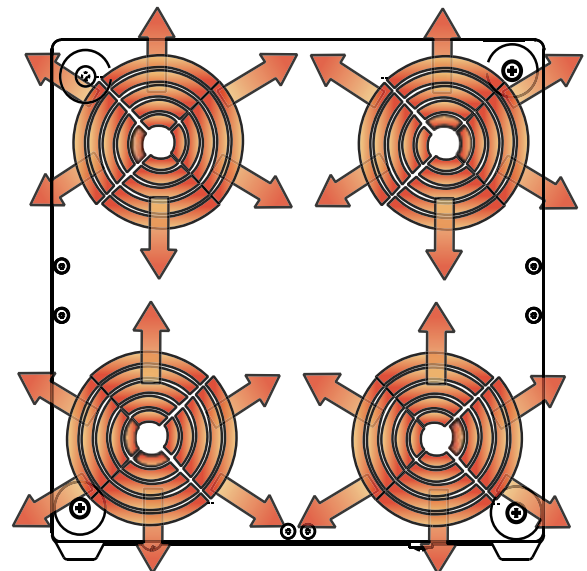

Figure 2.7.4: Rear Outlet

2.8 – Active Power Factor Correction

In electric power systems, a power supply with a low Power Factor will draw more current than the same power supply with a high Power Factor while doing the same work.

Power Factor (PF) in ac systems is defined as the ratio of the real power W (watts) flowing to the load over the apparent power VA (volts-amps) in the circuit. This is represented by a number between 0 and 1. For example: this is a percentage $.75PF=75\%PF$.

A power supply is considered to be a non-linear load in which the ac power is rectified and then filtered. It is these non-linear loads that reshape the current waveform into something different introducing harmonics and distortion known as THD (Total Harmonic Distortion).

THD is defined as the ratio of the sums of all the powers of the harmonics to the power of the fundamental frequency (i.e. the fundamental frequency would be the line frequency 60 Hz and the 2nd order harmonic=120 Hz, the 3rd order=240 Hz, etc.).

$$THD = \sqrt{\frac{\sum_{n \neq 1} I^2_n}{I_1^2}} \quad PF = \sqrt{\frac{1}{1 + THD^2}}$$

When the mains instantaneous voltage exceeds the voltage of the Input Capacitors the Rectifiers conduct which causes a current spike (see Figure 2.8.1). These spikes induce harmonics and distortion. These additional harmonics over the fundamental frequency are what contribute to a poor Power Factor. The higher order harmonics in the ac current cause the skin effect of the conductors carrying the ac currents to the load to increase.

Skin effect in ac circuits is where the higher frequency currents do not penetrate the entire conductor due to the opposing eddy currents causing them to ride along the surface of the conductor. It is these magnetic fields, generated by the eddy currents, which cause the resistivity of the conductor to increase with frequency.

This means the conductor needs to carry additional currents plus the load current to compensate for the higher order harmonics. These extra currents generate magnetic fields and are stored in the power lines, the switch gear and the power supply. They then return back to the power grid during the off periods of the cycle resulting in wasted energy in the form of heat.

Tesla™ Industries was able to develop a wide bandwidth active Power Factor Correction that runs from 40 Hz to 450 Hz which pulls unity power only at the fundamental frequency. This was achieved by forcing the current to follow the voltage waveform (see Figure 2.8.2) so that current is pulled through the entire sinusoidal waveform on a cycle-by-cycle basis. This eliminates the current spikes and strips out the additional harmonics causing a massive increase in efficiency.

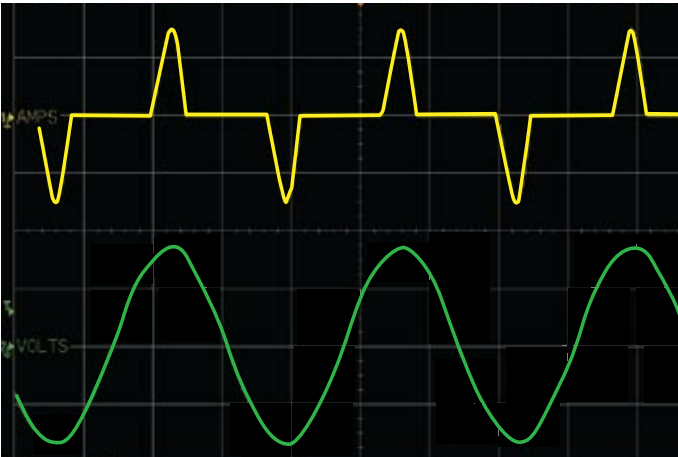

Figure 2.8.1 - Non-PFC Power Supply

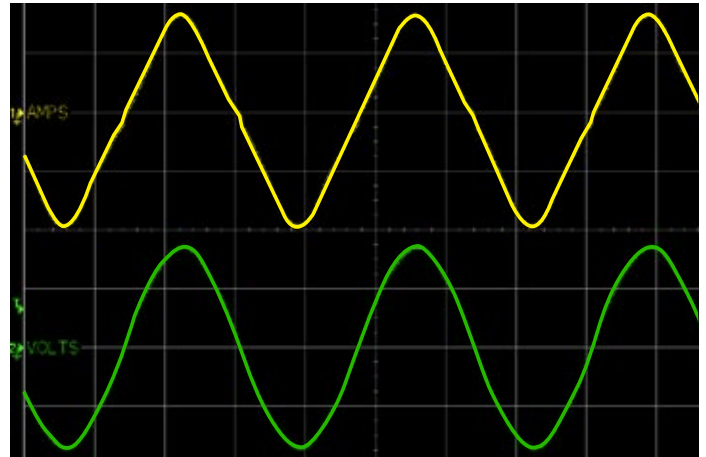

Figure 2.8.2 - Tesla's PFC Power Supply

2.9 – AC Input Circuit Breaker

This unit is equipped with a 35 Amp AC Input Circuit Breaker located above the AC Input Connector. The AC Input Circuit Breaker acts as an “On/Off” switch for the unit.

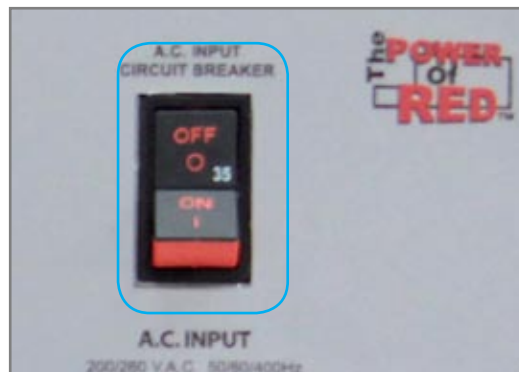

Figure 2.9.1 - AC Input Circuit Breaker (outlined in blue)

2.10 – AC Line Cord

The ac line cord is a 25' long S00W 600 Volt 8/3 Cable with a 50 Amp Twist Lock. (TI25000-058 (CS8265) 25ft. Hardwired Single Phase Plug AC Line Cord) 50 Amp service is required to use the TI200-PFC. Contact Tesla™ Industries for additional plug configurations.



Figure 2.10.1 Connecting TI200-PFC to AC Power Supply



Figure 2.10.2 50 Amp Twist Lock AC Line Cord

2.11 – 24 Vdc Output Connector

The 24 Vdc Output Connector provides 100 Amps of continuous power @ 28.5 Vdc (when plugged into ac power). When the Output Connector is not in use, cover the receptacle with the protective cover (see Figure 2.11.1). This will protect the Output Connector from dust and foreign matter.

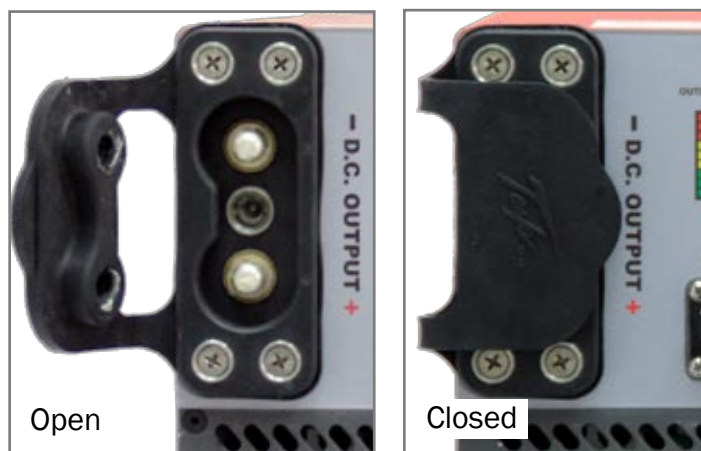

Figure 2.11.1 24 Vdc Output Connector Protective Cover

2.12 – Interface Connector

The Interface Connector is used by a Tesla™ factory technician to calibrate the TI200-PFC.

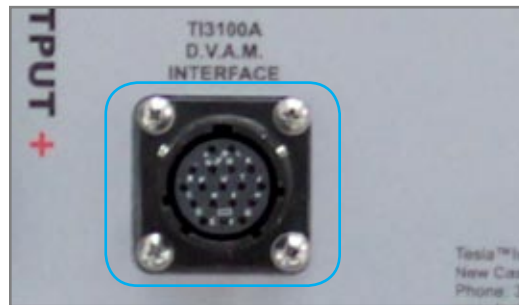

Figure 2.12.1 - Interface Connector location (outlined in blue)

2.13 – Output Power Status LED Indicator

The Output Power Status LED Indicator provides a way for the user to visually see the amount of available power that the TI200-PFC can supply. This lets the operator know if there is enough power to perform ground maintenance.

For example 1 green bar means 100% of power (100 amps) is available. 3 green bars means 80% (80 amps) of power is left. 3 green bars and 3 yellow bars means that only 50% (50 amps) is available and so on.



Figure 2.13.1 - Output Power Status Indicator location (outlined in blue)

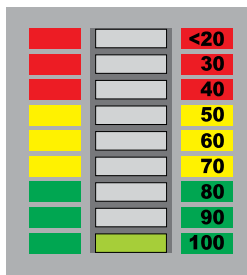

100% Output Power Remaining

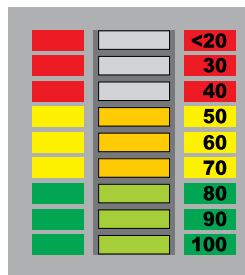

50% Output Power Remaining

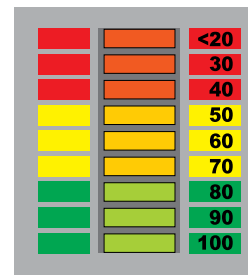



Less Than 20% Output Power Remaining

Section 3 – Operating Procedures

3.1 – Operating Procedures

This section concerns with normal procedures, and includes steps necessary to ensure safe and efficient operation of the TI200-PFC.

 NOTE	Unit is not rated for engine starting. It is to be used for ground maintenance only.
---	--

 NOTE	If current demand exceeds 200 amps, converter output voltage will drop below 28.5 Vdc and two or more LED status indicator bars will illuminate. If all LED status indicator bars illuminate, the converter is supplying 24 Vdc power output.
---	---

3.2 – General

Correct operation of the TI200-PFC includes both pre-use and operational checks of the unit. Knowledge of the operating limits, restrictions, performance, unit capabilities and functions is fundamental to correct and safe operation. The operator shall ensure compliance with the instructions in this manual that affect operational safety and the warranty of the unit.

3.3 – Operating Limits and Restrictions

The minimum, maximum and normal operating ranges result from careful engineering and evaluation of test data. These limitations must be adhered to during all phases of operation.

3.4 – Environmental

 WARNING	Operating any electrical equipment in the presence of moisture creates possible safety hazards and/or potential for equipment damage. Every effort has been made, within the scope of existing technology to prevent foreseeable safety hazards and make the unit moisture resistant to prevent damage or failure.
--	---

Operating any electrical equipment in the presence of moisture creates possible safety hazards and/or potential for equipment damage. Every effort has been made, within the scope of existing technology to prevent foreseeable safety hazards and make the TI200-PFC moisture resistant to prevent damage or failure. If the TI200-PFC is exposed to moisture, preventive measures and precautions shall be taken to:

- A. Prevent accumulation of moisture on ac and dc connectors/receptacles
- B. Minimize moisture entering forward inlet and aft outlet cooling fan vent ports

Unit inlet and outlet vent ports shall be covered from exposure. Unit shall be kept horizontal.

3.5 – Pre-Operation

1. Be sure to check that all input and output cables are not damaged. (See Section 5.1)
2. Check unit carefully for any evidence of damage. (See Section 5.2)
3. Make sure that airflow is not obstructed from air intake and outlet. (See Section 2.6)
4. Check that all connections are secure and free from water.



Figure 3.5.1 - TI200-PFC

3.6– Regulated AC Power

Plugging in with AC Power

When attaching the ac line cord, the user must make sure the plug is firmly seated all the way into the receptacle.



Figure 3.6.1 Connecting TI200-PFC to AC Power Supply

3.7 – Regulated 28.5 Vdc Ground Power

Connecting DC Power Cable To Unit

Attaching a dc plug is quick and easy. Line up the plug with the receptacle. Push forward while rotating the T-handle one full turn clockwise. Ensure dc power cable plug is fully seated into the GPU's dc receptacle. The unit is now ready to safely transfer power.



Figure 3.7.1 Attaching DC Power Cable to TI200-PFC

Connecting DC Power Cable To Vehicle or Aircraft

Line up the NATO plug or aviation dc plug pins and push it in. DC bus power should come on and aircraft voltmeter should indicate 24 Vdc to 23.5 Vdc (23 Vdc minimum). Ensure dc power cable plug is fully seated into the vehicle or aircraft's dc receptacle



Figure 3.7.2 Attaching DC Power Cable to ground vehicle



Figure 3.7.3 Attaching DC Power Cable to aircraft



NOTE

Unit is not rated for engine starting. It is to be used for ground maintenance only.

3.8 – Turning on AC Input Circuit Breaker

With the ac line cord plugged in and the dc cable connected to the TI200-PFC, push the ac rocker switch to the “On” position. After approximately 5-8 seconds, the unit’s LED status indicator will illuminate indicating output power status, and cooling fans will operate. When the TI200-PFC is operational the system will recondition and recharge vehicle batteries, power avionics, and any additional ground support.



Figure 3.9.1 - Turning On AC Input Circuit Breaker

Low Power Demand

Low power demand is defined by a requirement of 200 amps or less. If the load demand is less than 200 amps, converter output will remain at 28.5 Vdc (only one GREEN LED status indicator bar will illuminate). If load demand exceeds 200 amps converter voltage output will decrease and two or more LED status indicator bars will illuminate.

High Power Demand

High power demand is defined by a requirement of greater than 200 amps. Connect to aircraft ground power receptacle. DC bus power should come on and aircraft voltmeter should indicate 28.5 Vdc to 23.5 Vdc (23 Vdc minimum). If current demand is greater than 200 amps, converter output voltage will drop below 28.0 Vdc and LED status indicator lights will illuminate indicating current is being drawn from the power cells. The greater the current draw, the quicker the LED status indicator will approach red. Note the LED status indicator shows the status of the power cells.

3.9 – Removing DC Power Supply From Vehicle or Aircraft

1. Turn Off AC Input Circuit Breaker.
2. Remove dc power cable GPU connector from vehicle or aircraft. Follow the Installation Instructions in reverse.
3. Remove dc power cable connector from TI200-PFC (if necessary). Follow the Installation Instructions in reverse.
4. Reinstall dc receptacle’s protective cover.
5. Unplug ac line cord from the wall by twisting the plug a quarter turn counter-clockwise then pull out of the receptacle.

Section 4 – Post Operation

4.1 – General

Although the TI200-PFC has been ruggedized and made weather resistant within the scope of unit's intended use, it is essential that good general care be taken to maintain unit in good operating condition and to maximize unit's operational life.

4.2 – After Use

Unit should be protected from environmental elements and man made hazards. Ideally unit should be secured in a building or shed.

Section 5 – Unit Care and Maintenance



WARNING

Severe injury or death from electrical shock may occur, if either the user or the unit is wet, while the unit is connected to a power source.



CAUTION

The use of unapproved or modified ac line cable or input plug may damage the unit. Do not use any type of ac voltage converter.

5.1 - Unit Care

Avoid Prolonged Exposure to Extremely Damp Environments

If the unit has come into contact with water, disconnect ac power from the ac source. If the AC Input Circuit Breaker has tripped due to water infiltration, allow the unit to dry out before attempting to reset circuit breaker. Cover the unit to prevent water seepage. If the unit is operated in extremely damp conditions, it should be stored in an environmentally controlled building when not in use. Wipe unit clean periodically with a soft cloth to remove dust, dirt, etc.



Protect Cables from Damage

Do not cut, crush, or drag the input or output power cables when handling the unit. Always inspect cables prior to use. If no damage is evident, proceed to the next step. If damage is evident, contact Tesla™ Customer Service. Do not attempt to use any other type of power cables other than the Tesla™ cables included with the unit.



Figure 5.1.1 – Damaged cable

5.2 – Normal Function Test Procedures

This section involves with “normal function” test procedures, and includes steps necessary to ensure that the TI200-PFC is operating within specified parameters prior to use. A digital multimeter (an example is shown in Figure 5.2.1) capable of measuring dc and ac voltage and resistance will be required to perform some of the tests. These functional test procedures should become routine.



Figure 5.2.1 – Digital Multimeter

Check Unit for Evidence of Damage

Check for dents, punctures, case distortion or misalignment, and cracked or loose connectors. If no damage is evident, proceed to the next step. If damage is evident, contact Tesla™ Industries, Inc.

Check Unit Internal Resistance (Test for Shorts)



1. Set multimeter to Ohms.



2. Without ac power, place the negative probe on a screw of the DC Receptacle. Move the positive probe to the dc positive post. Multimeter should read “OL” (Open Line).



3. Without ac power, place the negative probe on a screw of the DC Receptacle. Move the positive probe to the dc negative post. Multimeter should read “OL” (Open Line).

Check DC Voltage Reading at DC Receptacle Terminals



1. Plug unit into ac power and turn on AC Input Breaker (see Section 3.7 and 3.9). One green LED should illuminate. Set multimeter to Vdc.



2. Testing dc receptacle, reading should be approximately 28.5.



3. Move the positive probe to the dc positive post. Reading should be 0.



4. Move the positive probe to the dc negative post. Reading should be 0.

5.3 – Unit Servicing

The TI200-PFC is a maintenance-free, sealed unit. No repairs outside of Tesla™ are authorized. Warranty will be voided if unit is tampered with in any way including any damage to the WARRANTY VOID stickers located on the case (see Figure 5.3.1 below). If the unit requires maintenance, please contact Tesla™ Customer Service at (302) 324-8910. A Repair Request Form can be found in the back of this manual.

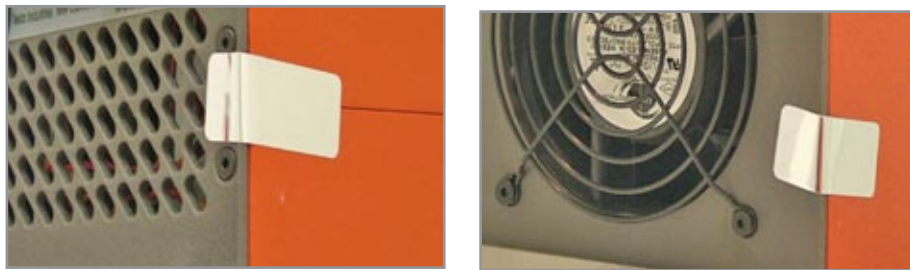

Figure 5.3.1 – Warranty Void stickers Front and Back on the TI200-PFC

5.4 – Transporting Unit

The TI200-PFC can be carried for short distances by hand. If the area of operation is further than 45 meters (150 feet) the TI200-PFC should be transported on a vehicle or in the TI7000-116 Transport Dolly (see Section 8 - Optional Accessories).



Figure 5.4.1 TI7000-116 Transport Dolly

5.5 – Packaging and Shipping

When returning the GPU, please ensure that it is properly packaged. The only method for transport is in a sturdy shipping crate (be sure to enclose the Repair Request Form). Seal the crate on all sides and return it to Tesla™ at the address listed below. Please contact Tesla™ Customer Service at (302) 324-8910 with any questions or concerns.

TESLA™ INDUSTRIES, INCORPORATED
101 CENTERPOINT BLVD.
CENTERPOINT INDUSTRIAL PARK
NEW CASTLE, DELAWARE 19720
PHONE: (302) 324-8910 FAX: (302) 324-8912
Website: www.teslaind.com Email: Tesla1@teslaind.com

Section 6 – Troubleshooting and FAQ

6.1 – Frequently Asked Questions

1. Why should I buy a Tesla™ Power Supply?

Tesla™ Power Supply are multi-functional systems that are ideal for support of 24 Vdc vehicles and aircraft and their electronics/avionics on the bench. Tesla™ manufactures various systems, of different sizes and capacities, that are man-portable, maintenance free and provide pure, flat-line dc power in a completely safe package. Designed for Military applications, these systems are equally valuable in maintenance support at the main facility or in remote locations. They are easily transported and air-portable. They will also provide 28.5 Vdc when the system is connected to the appropriate ac source.

2. How are Tesla™ Power Supply used in Aviation Support?

There are many ways a Tesla™ Power Supply will benefit your operation. By using it for pre-flight testing, you will avoid depleting the aircraft's battery. In the hangar, when connected to ac power, the Tesla™ Power Supply will provide 28.5 Vdc for avionics testing.

3. How much power will my Tesla™ Power Supply provide?

The TI200-PFC will provide up to 200 amps of continuous, regulated dc power at 28.5 Vdc.

4. Is it waterproof?

Water-resistant but not waterproof.

5. Are Tesla™ Power Supply's used in shop maintenance and testing?

Tesla™ systems are gaining popularity throughout maintenance facilities, instructional facilities, laboratories, manufacturing plants, aircraft hangars and many other locations. The reason is due to the precise flat line dc power, the small, portable and quiet nature of our systems and the maintenance free aspect of our GPU's. We can custom tailor ground power systems to fit your individual requirements.

6. Can one person transport it?

The TI200-PFC is designed to be handled by one person. The TI200-PFC weighs 29.5 lbs and can be carried or wheeled on a dolly (TI7000-184).

7. How do I get my Tesla™ Power Supply serviced?

Contact Tesla™ Customer Service at (302) 324-8910. You can also email us at tesla1@teslaind.com. Once we receive the unit at our facility, we will examine it. Systems that are protected under warranty will be repaired at no charge. If the warranty has expired, you will receive a quote for necessary repairs prior to work being done. Our turnaround time is 48 hours once repairs are authorized.

8. Can I make my own repairs to unit?

During the warranty period, the unit can only be repaired by Tesla™ Industries for the warranty to remain in effect. Regardless, we strongly recommend allowing Tesla™ to repair any unit as we will analyze the complete system and re-calibrate it.

9. What type of maintenance does the Tesla™ Power Supply require?

The systems is maintenance free. Keep the vent areas clean and free of debris. Keep the unit in a protected environment when not in use (maintenance facility, shed).

10. What is included with my Tesla™ Power Supply?

Aviation customers will receive an eight (8') foot DC cable with an aviation plug. Ground vehicle customers will receive a fifteen (15') foot dc cable with terminal ends. This cable requires a NATO plug, alligator Clamps or another connector prior to its use. Tesla™ can provide these connectors at an additional charge. Both customers receive an ac line cord for their home country and a full two year warranty.

11. Are there any HAZMAT issues or disposability problems?

There are none. Contact Tesla™ if you have questions.

6.2 - Basic Unit Troubleshooting

Fault	Possible Cause	Remedy
<p>1. Output Capacity LED does not come on.</p>	<p>A. Circuit Breaker has tripped. B. No outlet power.</p>	<p>A. Plug the unit in to the appropriate ac power outlet. B. If LEDs still do not illuminate, C. Please contact Tesla™ Customer Service at (302) 324-8910</p>
<p>2. Unit will not power from ac Outlet.</p>	<p>A. AC line cord is damaged or bad. B. Is ac line cord fully plugged into unit and wall outlet. C. AC circuit breaker has been tripped. D. No ac power at outlet.</p>	<p>A. Do a continuity test on the ac line cord B. Check if line cord is properly secured. C. Check to make sure ac circuit breaker is placed in the “ON” position.</p>
<p>3. Unit failed function test.</p>	<p>A. Internal failure.</p>	<p>A. Please contact Tesla™ Customer Service at (302) 324-8910</p>
<p>4. Unit emits sparks when plugged into power source.</p>	<p>A. Water or moisture has seeped in unit B. Internal failure.</p>	<p>A. Move unit to dry warm air and allow to dry for over 48 hours. B. Do Not Use Unit. Please contact Tesla™ Customer Service at (302) 324-8910</p>
<p>5. Unit works then shuts down.</p>	<p>A. Unit is overheating. B. Cooling fans and vents are obstructed or inoperable.</p>	<p>A. Move the unit to an area 10° -20° less ambient temperature. B. Clean and clear cooling vents, turn on unit and inspect if air is flowing through unit. If no airflow please contact Tesla™.</p>
<p>6. Circuit breaker continuously trips</p>	<p>A. Unit is overheating. B. Internal Short</p>	<p>A. Disconnect unit from ac input and dc output. B. Switch breaker to ON position. C. Reconnect unit to cables and run. D. If LEDs still do not illuminate, Please contact Tesla™ Customer Service at (302) 324-8910</p>
<p>7. Unit does not put out 28.5 volts dc power.</p>	<p>A. Unit is not plugged in.</p>	<p>A. Plug unit into ac power source to maintain 28.5.</p>

Section 7 – Optional Accessories

7.1 – Transport Dolly

The Tesla™ TI7000-116 is a custom stainless steel dolly designed especially to transport the TI200-PFC. The TI7000-116 is the safest and easiest way to support and transport the TI200-PFC out in the field and through hangars and flight lines. The Transport Dolly comes with a 2-year warranty.



7.2 – Cobra™ DC Replacement Contacts and Tools

Cobra™ DC Plugs provide reliable high-power connections up to 3000 amps – even in the harshest conditions. A rugged combination of advanced composite materials and corrosion-resistant alloys make each plug maximized for durability and connectivity. To extend the life of the Cobra™ Connector included with your unit, replacement contacts, posts, noses and tools can be ordered through the Tesla™ Customer Service.

TI2005-238

Cobra™ Aviation Plug



TI2005-078

Cobra™ NATO Connector
NSN: 6130-01-523-1270 (CL IX)



TI2005-251

DC Aviation Plug
Positive/Negative
Contact



TI2005-654

DC 400Hz Aviation Plug
Positive/Negative
Contact



TI2004-444

NATO Replacement Post
For newer NATO plugs with new style post, indicated by the black tip. Replacement plug uses standard 3/4" deep well socket for installation.



TI2005-250

DC Aviation Plug
3-slotted Connector



TI2005-239

Aviation Insertion/
Extraction Tool



TI2005-121

NATO Negative Contact
NSN: 5999-01-525-0582 (CL IX)



TI2005-117

NATO Positive Post
NSN: 5935-01-523-8914 (CL IX)



TI2004-341

Replacement Nose for
Aviation Plug



TI2004-340

Replacement Nose for
400Hz Aviation Plug



TI2005-126

NATO Negative Contact
Insertion/Extraction Tool
NSN: 5120-01-523-8761 (CL II)



TI27000-082

NATO Positive Contact
Insertion/Extraction Tool
NSN: 5120-01-527-7729 (CL II)



Repair Request Form

Please complete the information below to ensure prompt and accurate service. Include this form with the unit you are returning. Thank you.

Date of return: _____

Company name & _____

Billing address: _____

Contact person: _____

Phone #: _____ Fax #: _____

Email: _____

Purchase Order #: _____

Model #: _____ Serial #: _____

Model #: _____ Serial #: _____

Shipping method to Tesla™: _____

Description of shipping package: _____

Description of problem: _____

Return to Tesla™

101 Centerpoint Boulevard, New Castle, DE 19720 Attention: Repair Department



WE GET THE MILITARY STARTED!

Tesla™

101 Centerpoint Blvd.
New Castle, DE 19720 USA
Tel: 302-324-8910
Fax: 302-324-8912

9475 Double R Blvd., Suite 2
Reno, NV 89521
Tel: 775-622-8801
Fax: 775-622-8810

www.teslaind.com ♦ www.tesla1.com